

XC5101- 1A Linear Li-Ion Battery Charger

GENERAL DESCRIPTION

The XC5101 is a complete constant current & constant voltage linear charger for single cell lithium-ion batteries. Its SOP package and low external component count make the XC5101 ideally suited for portable applications. Furthermore, the XC5101 is specifically designed to work within USB power specifications.

No external sense resistor is needed, and no blocking diode is required due to the internal MOSFET architecture. Thermal feedback regulates the charge current to limit the die temperature during high power operation or high ambient temperature. The charge voltage is fixed at 4.21V, and the charge current can be programmed externally with a single resistor. The XC5101 automatically terminates the charge cycle when the charge current drops to 1/10th the programmed value after the final float voltage is reached.

When the input supply (wall adapter or USB supply) is removed, the XC5101 automatically enters a low current state, dropping the battery drain current to less than 2uA. The XC5101 can be put into shutdown mode, reducing the supply current to 50uA.

Other features include Battery temperature monitor, under-voltage lockout, automatic recharge and two status pins to indicate charge and charge termination.

FEATURES

- Programmable Charge Current Up to 1000mA
- No MOSFET, Sense Resistor or Blocking Diode Required
- Complete Linear Charger in SOP Package for single Cell Lithium-Ion Batteries
- Constant-Current/Constant-Voltage Operation with Thermal Regulation to Maximize Charge Rate Without Risk of Overheating
- Charges Single Cell Li-Ion Batteries Directly from USB Port
- Preset 4.21V Charge Voltage with $\pm 1\%$ Accuracy
- Charge Current Monitor Output for Gas Gauging
- Automatic Recharge
- Charge state pairs of output, no battery and fault status display
- C/10 Charge Termination
- 50uA Supply Current in Shutdown
- 2.9V Trickle Charge Threshold
- Soft-Start Limits Inrush Current
- Battery temperature monitoring function
- ESD HBM 8KV
- Available in SOP8-PP Package

APPLICATIONS

- Cellular Telephones, PDAs, MP3 /MP4 Players
- Charging Docks and Cradles
- Bluetooth 、 GPS Applications

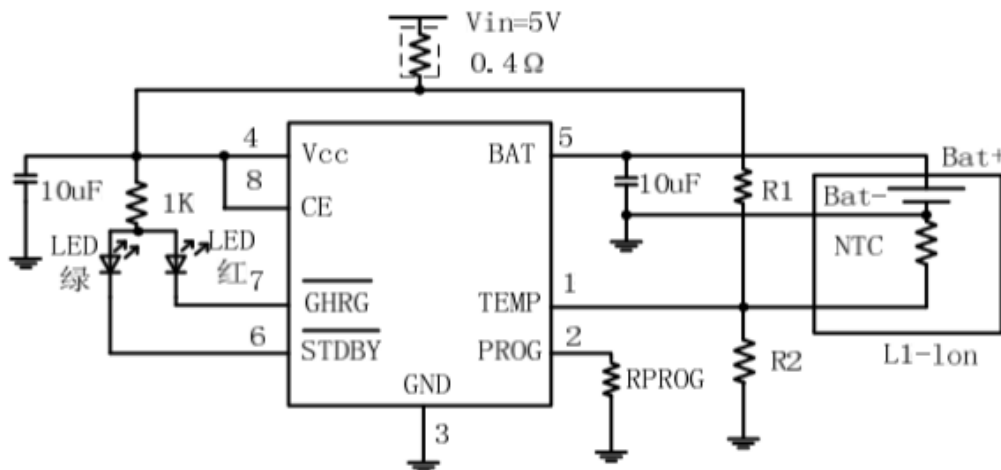

Figure1 . Typical Application Circuit

ORDERING INFORMATION

PART NUMBER	TEMP RANGE	VIN	VBAT	CHARGE CURRENT	PACKAGE	PINS
XC5101	-40°C to 85°C	4.5~6V	4.21V	1A	SOP-PP	8

PIN CONFIGURATION

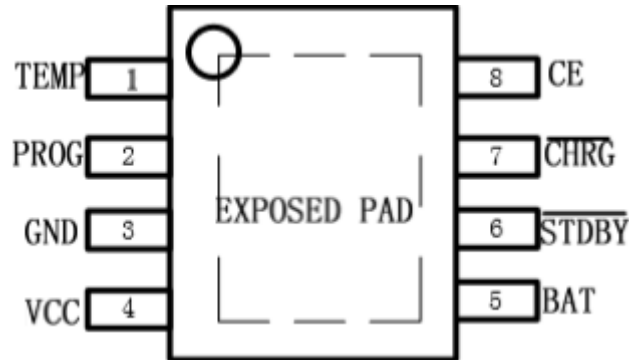

Figure 2. PIN Configuration

PIN DESCRIPTION

PIN NUMBER	PIN NAME	PIN DESCRIPTION
1,	TEMP	Battery temperature detection input
2	PROG	Charge Current Program, Charge Current Monitor and Shutdown Pin.
3	GND	Ground
4	VCC	Positive Input Supply Voltage.
5	BAT	Charge Current Output.
6	/STBY	The completion of battery charging instructions side.
7	/CHRG	Open-Drain Charge Status Output.
8	CE	Chip enable input.
9	EPAD	Ground and EPAD

ABSOLUTE MAXIMUM RATINGS

(Note: Do not exceed these limits to prevent damage to the device. Exposure to absolute maximum rating conditions for long periods may affect device reliability.)

PARAMETER	VALUE	UNIT
Input Supply Voltage VCC	VSS-0.3 ~ VSS+7	V
PROG pin Voltage Vprog	VSS-0.3 ~ Vcc+0.3	V
BAT pin Voltage Vbat	Vss-0.3 ~ 7	V

CHAG pin Voltage Vchrg	VSS-0.3 ~ VSS+7	V
BAT pin Current Ibat	1.4	A
PROG pin Current Iprog	1.4	mA
Operating Ambient Temperature	-40 to 85	°C
Maximum Junction Temperature	150	°C
Storage Temperature	-55 to 150	°C
Lead Temperature (Soldering, 10 sec)	260	°C

ELECTRICAL CHARACTERISTICS

($V_{IN} = 3.6V$, $T_A = 25^\circ C$ unless otherwise specified)

PARAMETER	SYMBOL	TEST CONDITIONS	MIN	TYP	MAX	UNIT
Input Voltage Range	VCC		4.25		6.5	V
Input supply current	Icc	Charge mode, RPROG =10K		350	2000	uA
		Standby mode		150	500	uA
		Shutdown mode(RPROG not connected, Vcc<Vbat or Vcc<Vuv)		50	100	uA
BAT pin Current	Ibat	RPROG =2k, Current mode	450	500	550	mA
		RPROG =1k, Current mode	900	1000	1100	mA
		Standby mode, Vbat=4.2V	0	-2.5	-6	uA
		Shutdown mode		1	2.5	uA
		Sleep mode, Vcc=0V		0.3	2.5	uA
Regulated Charge Voltage	Vfloat	0°C ≤ TA ≤ 85°C, Icharge = 40mA	4.17	4.21	4.242	V
PROG pin Voltage	Vprog	RPROG =1k, Current mode	0.93	1.0	1.07	V
Trickle charge current	Itrikl	Vbat<Vtrikl, Rprog=1k	90	100	110	mA
Trickle charge Threshold Voltage	Vtrikl	RPROG =10K, Vbat Rising	2.8	2.9	3.0	V
Trickle voltage hysteresis voltage	Vtrhys	RPROG =10K	60	80	110	mV
Recharge Battery threshold Voltage	Δ Vrecg	VFLOAT - VRECHRG		150	300	mV
CHRG pin Output low voltage	Vchrg	Ichrg=5mA		0.35	0.6	V
STDBY pin Output low voltage	Vstdby	Istdby=5mA		0.35	0.6	V
Enable Threshold		VCC=4.25V~6.5V	0.3	1	1.5	V
Enable Leakage Current			-0.1		+0.1	uA
TEMP pin voltage of the high-end flip	Vtemp-h			80	82	%Vc c

TEMP pin voltage of the low-end flip	Vtemp-I		43	45		$\%V_{c}$ c
--------------------------------------	---------	--	----	----	--	----------------

PIN FUNCTION

TEMP (PIN 1): Battery temperature detection input.

TEMP pin to receive the battery NTC sensor output.

If the TEMP pin voltage is less than the input voltage is greater than 45% or 80% of the input voltage means the battery temperature is too low or too high, then the charge has been suspended.

If the TEMPdirect access GND, battery temperature detection canceled, the other charged and functioning properly.

PROG (PIN 2): Charge Current Program, Charge Current Monitor and Shutdown Pin.

The charge current is programmed by connecting a 1% resistor, RPROG, to ground. When charging in constant-current mode, this pin serves to 1V. In all modes, the voltage on this pin can be used to measure the charge current using the following formula:

$$IBAT = (VPROG/RPROG) \times 1000.$$

The PROG pin can also be used to shut down the charger. Disconnecting the program resistor from ground allows a 3uA current to pull the PROG pin high. When it reaches the 1.21V shutdown threshold voltage, the charger enters shutdown mode, charging stops and the input supply current drops to 50uA. This pin is also clamped to approximately 2.4V. Driving this pin to voltages beyond the clamp voltage will draw currents as high as 1.5mA. Reconnecting RPROG to ground will return the charger to normal operation.

GND (PIN 3): Ground.

VCC (PIN 4): Positive Input Supply Voltage.

Provides power to the charger, VCC can range from 4.25V to 6.5V and should be bypassed with at least a 10uF capacitor. When VCC drops to within 30mV of the BAT pin voltage, the XC5101 enters shutdown mode, dropping IBAT to less than 2uA.

BAT (PIN 5): Charge Current Output.

Provides charge current to the battery and regulates the final float voltage to 4.2V. An internal precision resistor divider from this pin sets the float voltage which is disconnected in shutdown mode.

STDBY (PIN 6): The completion of battery charging instructions side.

When the battery charge is complete, STDBY pulled low by internal switches, indicating the completion of charging. In addition, STDBY pin will be in a high-impedance state.

CHRG (PIN 7): Open-Drain Charge Status Output.

When the battery is charging, the CHRG pin is pulled low by an internal N-channel MOSFET. When the charge cycle is completed, CHRG pin will be in a high-impedance state.

CE (PIN 8): Chip enable input.

High input level will make XC5101 in normal working condition; low input level so that XC5101 is prohibited charging status. CE pin can be TTL or CMOS level-level driver.

TYPICAL PERFORMANCE CHARACTERISTICS

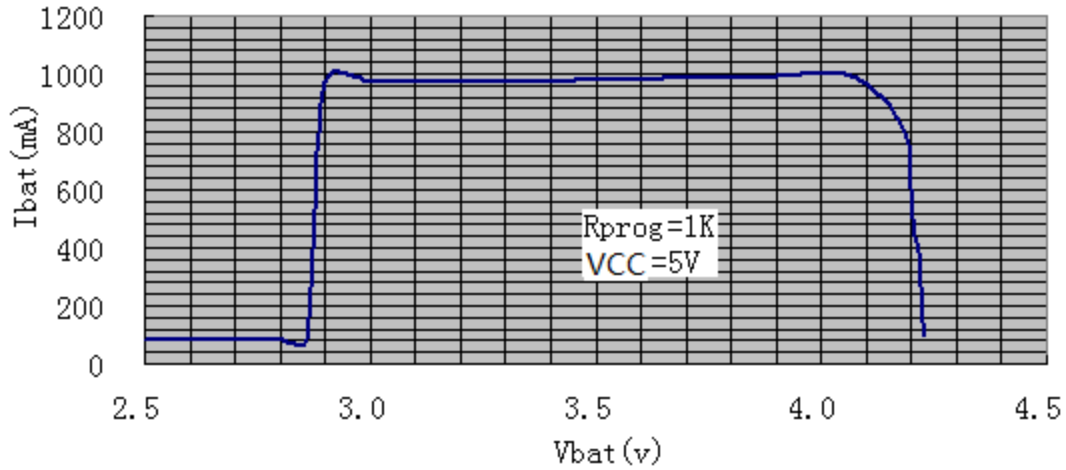

BATTERY CHARGER CURVE

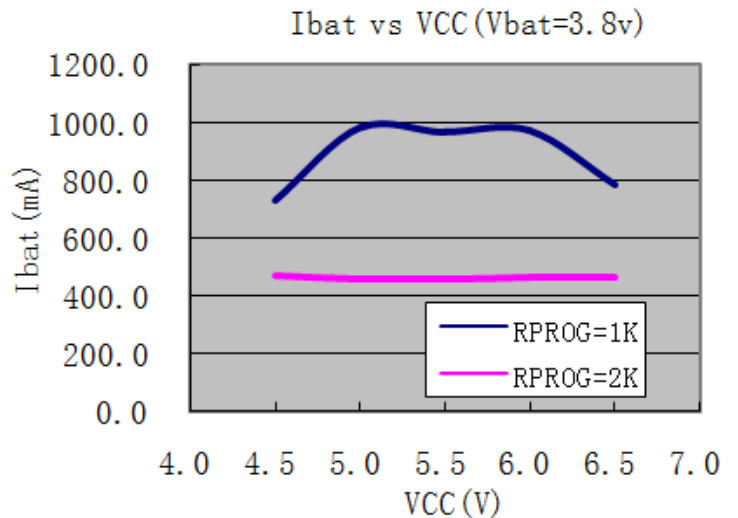
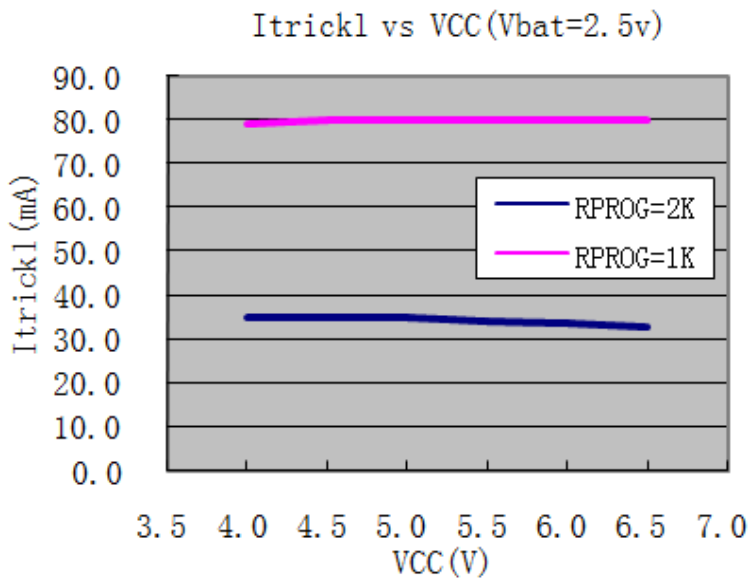
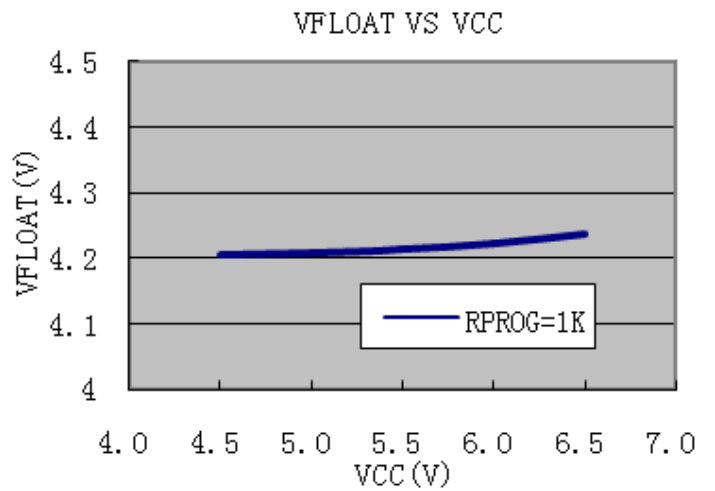
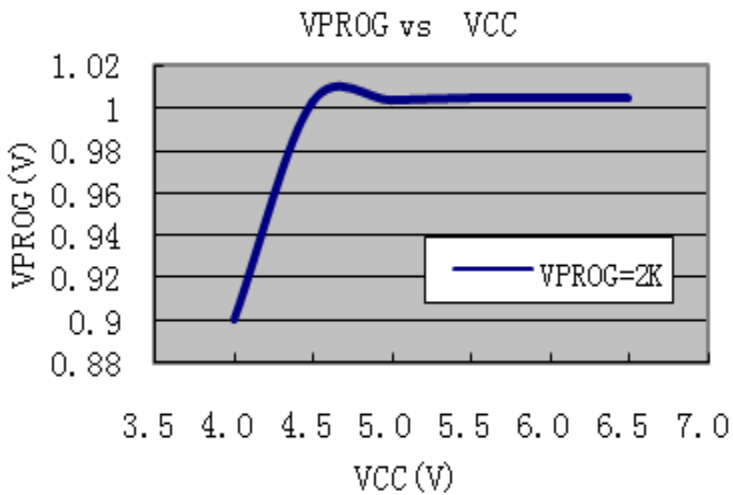

PROG PULL-UP CURRENT VS VPROG

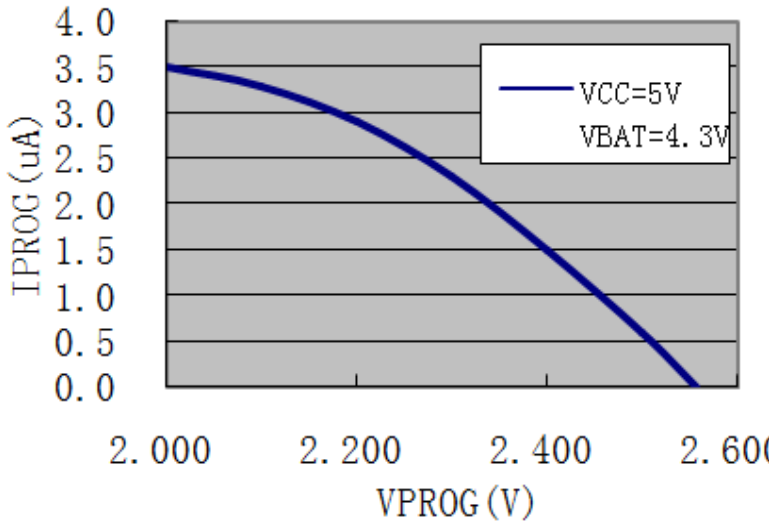

PROG CLAMP CURRENT VS VPROG

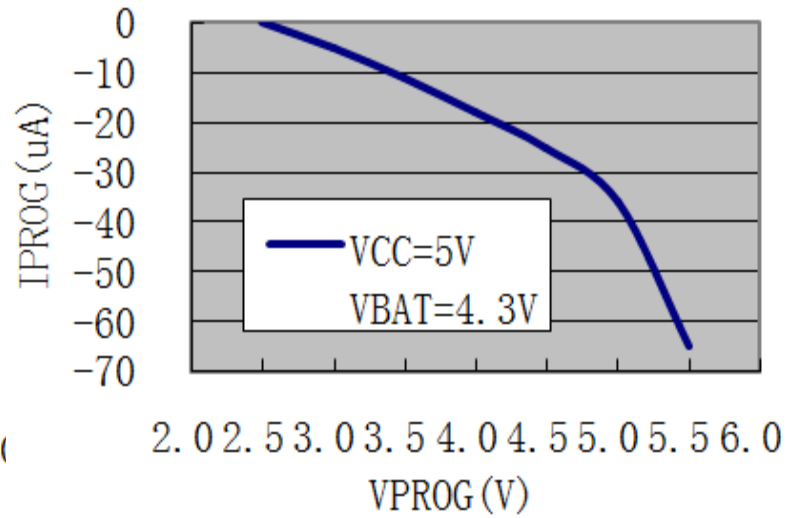

CHARGE CURRENT VS TEMP

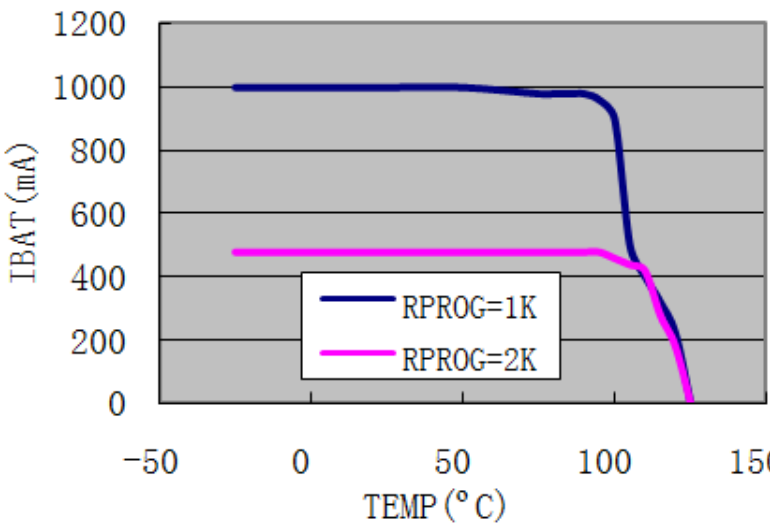

VPROG VS Temperature

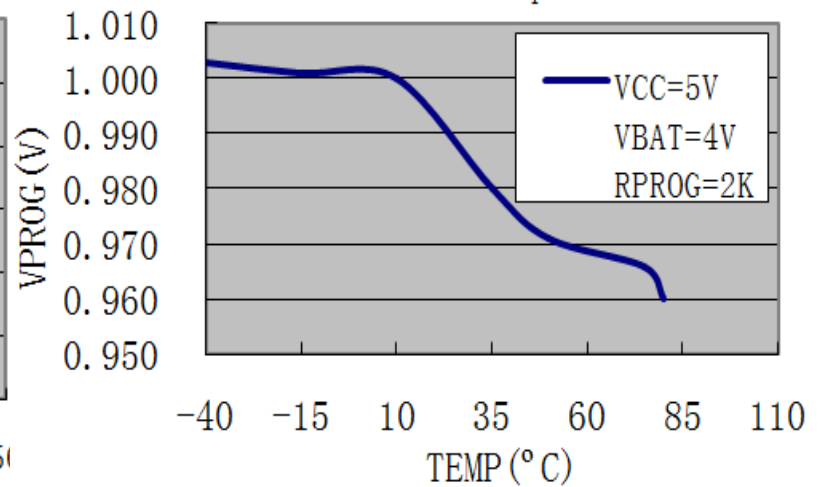

PROG PULL-UP CURRENT VS TEMP
(VCC=5V VBAT=4.3V)

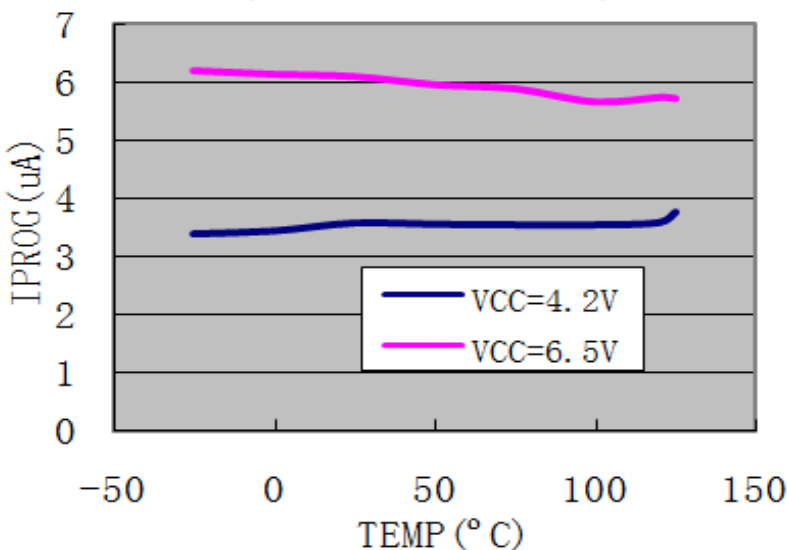

PACKAGE OUTLINE

SOP8-PP PACKAGE OUTLINE AND DIMENSIONS

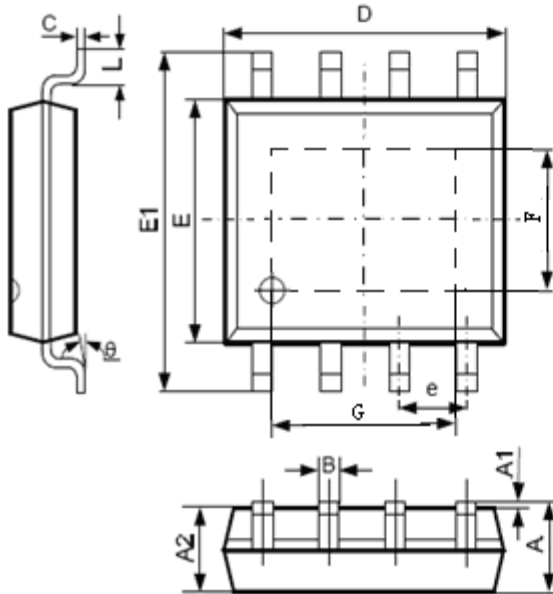

SYMBOL	Dimension in Millimeters		Dimension in Inches	
	MIN	MAX	MIN	MAX
A	1.300	1.700	0.051	0.067
A1	0.000	0.100	0.0	0.004
A2	1.350	1.550	0.053	0.061
B	0.330	0.510	0.013	0.020
C	0.170	0.250	0.007	0.010
D	4.700	5.100	0.185	0.201
E	3.800	4.000	0.150	0.157
E1	5.800	6.200	0.228	0.244
e	1.27 TYP		0.050 TYP	
L	0.400	1.270	0.016	0.050
θ	0°	8°	0°	8°
F	2.313	2.513	0.091	0.099
G	3.202	3.402	0.126	0.134

In order to increase the driver current capability of XC5101 and improve the temperature of package, Please ensure Epad and enough ground PCB to release energy.

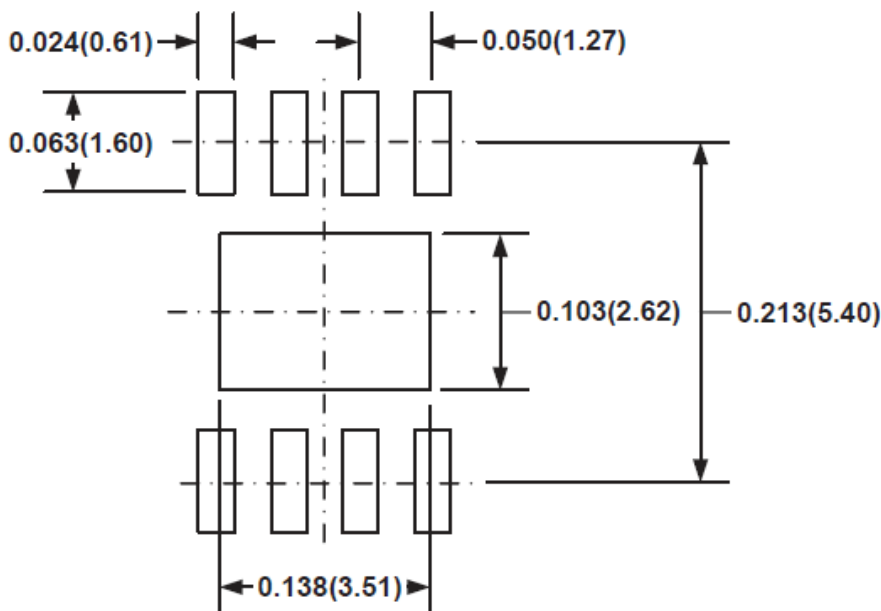

PROUCT CHANGE NOTICE LIST

NO	Updated date	Version update	Update content
1	2013-10-24	Rev 0.1	Create datasheet
2	2013-12-16	Rev 0.2	Update Vbat Parameter value
3	2013-12-18	Rev 0.3	Add ESD HBM 8KV
4	2014-3-28	Rev 0.4	Update Vbat Parameter range